

ADDENDUM NO. 1

TO
THE CONTRACT DOCUMENTS
FOR THE CONSTRUCTION OF

US19 RECLAIMED WATER TRANSMISSION SYSTEM - PHASE I

IN
HERNANDO COUNTY, FLORIDA
SOLICITATION NO. 18-CG0042/BH
BID DATE: FEBRUARY 14, 2018

NOTICE

BIDDERS ARE REQUIRED TO ACKNOWLEDGE RECEIPT OF
THIS ADDENDUM BY SIGNATURE AT THE BOTTOM OF
THIS ADDENDUM IN THE SPACES PROVIDED AND
RETURNED AT THE TIME OF THE BID DATE.

TO ALL PLAN HOLDERS:

The following changes, additions and/or deletions are hereby made a part of the Contract Documents for the **US19 RECLAIMED WATER TRANSMISSION SYSTEM - PHASE I**, located in Hernando County, as fully and completely as if the same were fully set forth therein:

A. SECTION X - REFERENCE DOCUMENTS

1. Replace Exhibit C – UTILITY DETAILS (2), sheet No. D-101 from the Bid Document with Attachment A – UTILITY DETAILS (2), sheet No. D-101 located herein for all bidding purposes. Revision: The ARV detail on sheet D-101 needs to have the color Blue changed to Purple in regards to the 2" PET.

A. QUESTIONS AND ANSWERS

1. Question: On page 3-9 2.2 of the spec packet it states all mechanical joint fittings shall meet requirements of ANSI/AWWA C110.... Our question becomes will C153 fittings also be allowed as an approved equal as the PSI ratings meet the specs?

Answer: Yes, C153 fittings are acceptable.

2. Question: On the bid form 5.5 the HDD portion of the job calls out for Fusible PVC. Our question is will HDPE be acceptable option? Or is the County only using FPVC.

Answer: The County requires fusible PVC only.

3. Question: We also had questions regarding the ARV's on this job. When looking at the plans and comparing to the Bid Form quantities some concerns were raised. On 11 of the ARV's they call for an Above Ground ARV, but when looking at the actual drawing they are drawn as an offset below ground. We are really just looking to confirm exactly which ARV's are required on this job in the locations where it is drawn with what appears to be a tee, but is called as an above ground which would us a saddle. The Stations included but may not be limited to: C-102, STA 878+90; C-104, STA 910+50; 115, STA 1034+55; 1043+00; C-118, STA 1071+45; C-120, STA 27+50; C-122, STA 1+30; C-123, STA11+20; C-124, STA 9+00; C-115, STA 1034+55; 1043+01.

Answer: The ARV symbol used on the plans is just a symbol. Refer to the call out for the symbol to determine if the ARV is an above ground or below ground ARV. The ARV's that are called out as above ground, which are also offset installations, will use the detail on sheet D-101. The ARV's that are called out as below ground are also in-line installations and will use the detail on sheet D-100 for in-line ARV installations. Note: There is an error with the above ground detail on sheet D-101. The 2" poly tubing (PET) is called out as Blue and it should be Purple for reclaimed water use. See Attachment A for the revised sheet D-101 located herein.

4. Question: Are we able to use C153 fittings instead of C110 Fittings?

Answer: Yes, C153 fittings are acceptable.

5. Question: Are we able to use HDPE instead of FPVC for the directional drilling?

Answer: No, use FPVC only.

6. Question: Can we get the contacts for the Timber Pines Golf Course so that we may schedule a site visit and also correlate with grounds management to restore grounds back to normal after work is completed?

Answer: Vendor/Contractors who attended the pre-bid meetings will be allowed access to the site. The County has provided the sign-in sheets to Timber Pines Management for verification. Vendor/Contractors wishing to visit Timber Pines for a site visit must provide to security personnel who they are, what company they are with and the reason for their visit.

Acknowledged

Issued: January 22, 2018

BOARD OF COUNTY COMMISSIONERS
HERNANDO COUNTY

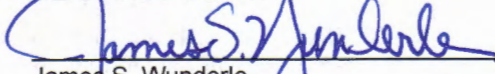

James S. Wunderle
Purchasing and Contracts Manager
Chief Procurement Officer

ATTACHMENT "A"

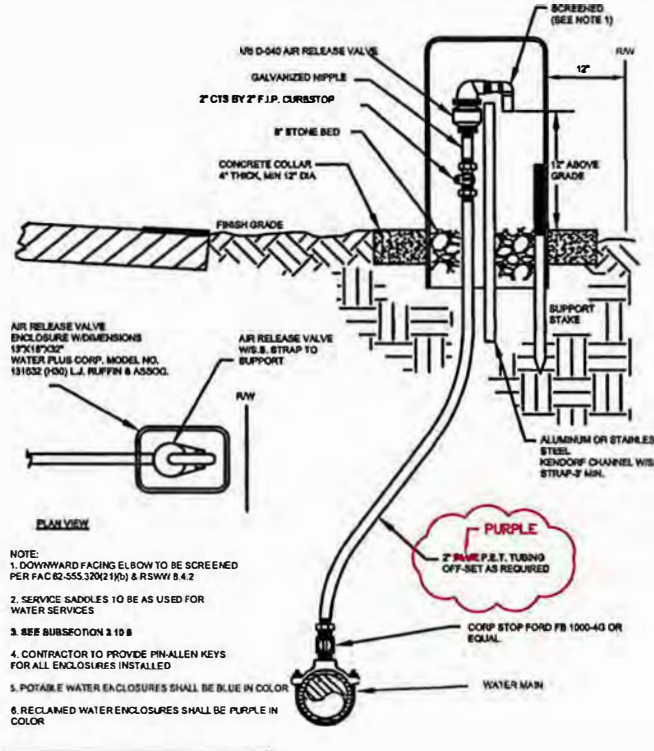

WATER: AIR/VACUUM RELEASE VALVE DETAIL
SCALE: NONE

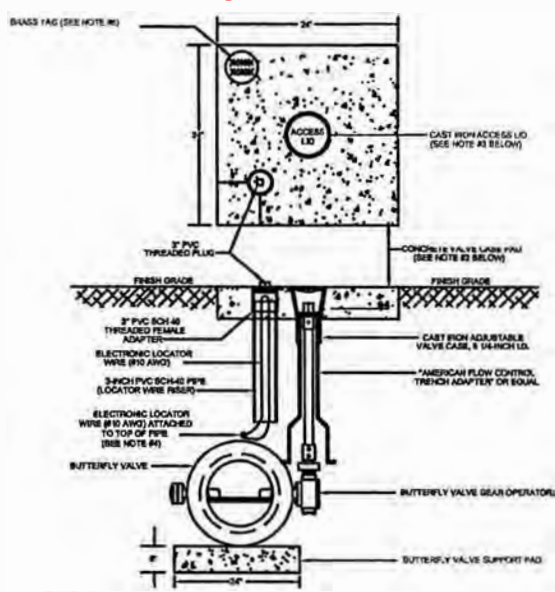

BUTTERFLY VALVE ASSEMBLY DETAIL
SCALE: NONE

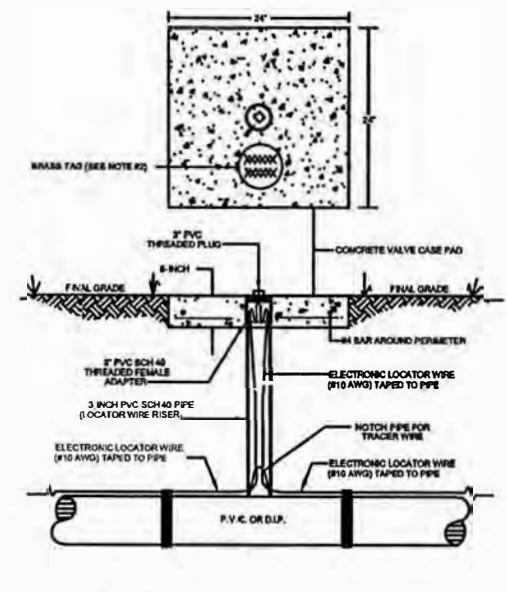

ELECTRONIC LOCATOR WIRE AND RISER DETAIL
SCALE: NONE

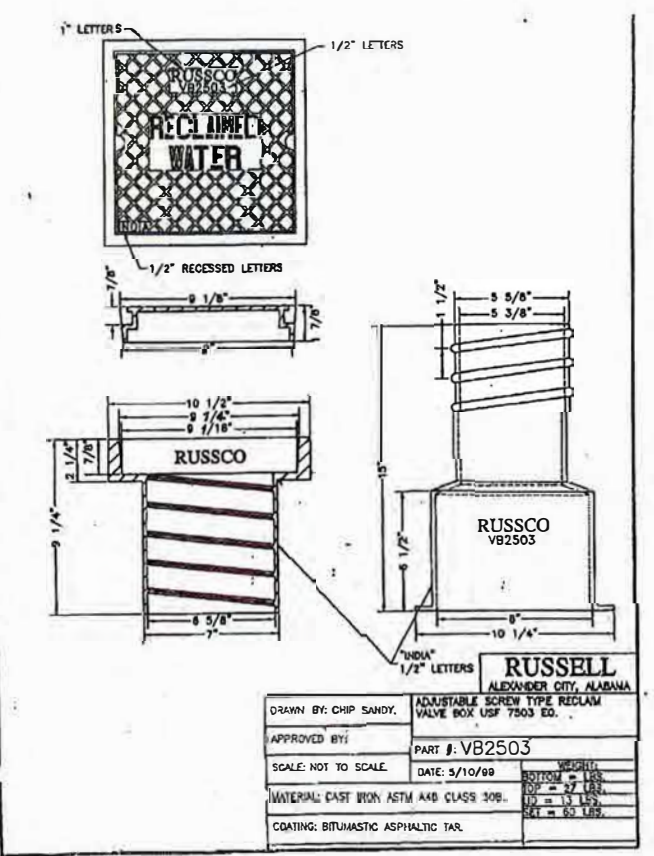

RUSSELL
ALEXANDER CITY, ALABAMA
ADJUSTABLE SCREW TYPE RECLAIM VALVE BOX USF 7503 EQ.
PART #: VB2503
DATE: 5/10/09
MATERIAL: CAST IRON ASTM A48 CLASS 30B.
COATING: BITUMASTIC ASPHALTIC TAR.

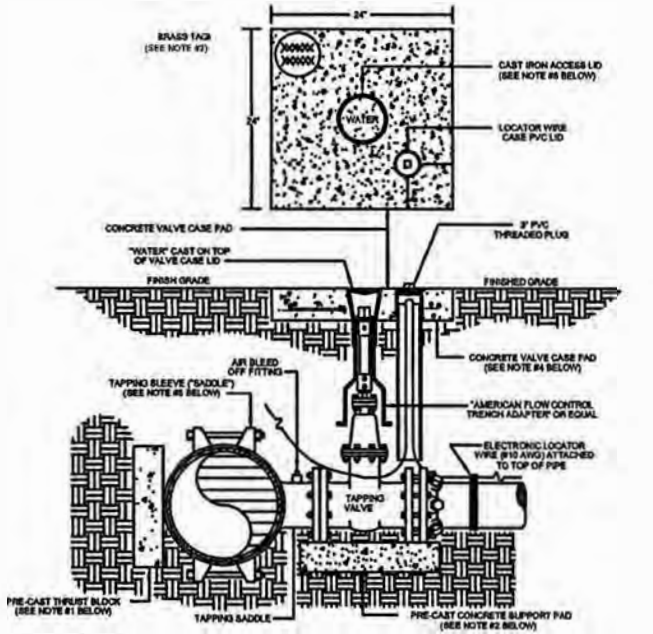

WET TAP AND VALVE ASSEMBLY DETAIL
SCALE: NONE

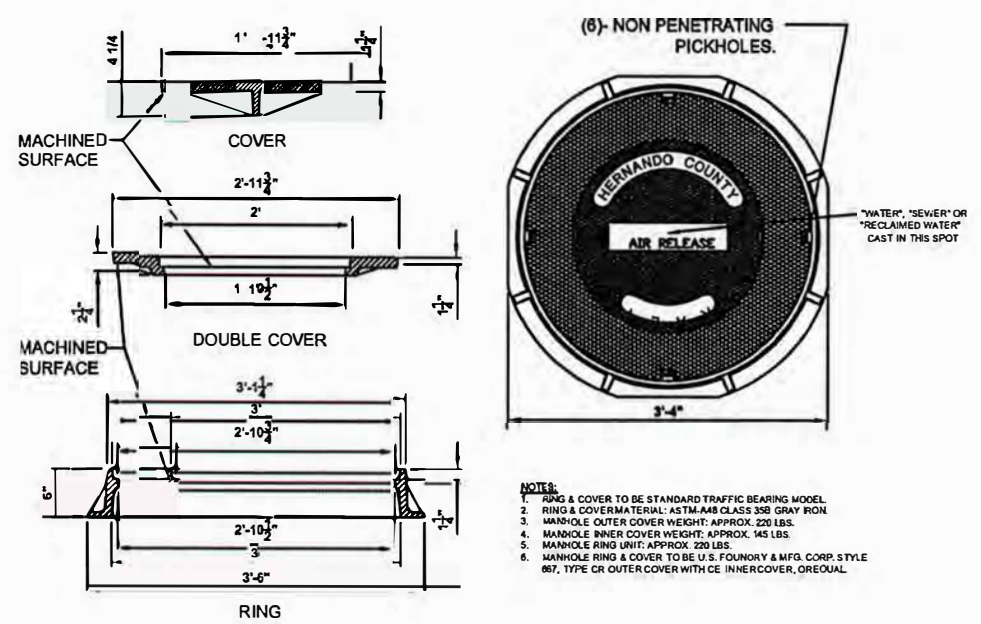

MANHOLE RING & COVER DETAIL
SCALE: NONE

NO.	DESCRIPTION	BY	DATE

Verify Scale
bar is one inch on original drawing
if not one inch on this sheet, adjust scale accordingly

Prepared By:
HERNANDO COUNTY UTILITIES DEPARTMENT



HERNANDO COUNTY UTILITIES DEPARTMENT
15365 CORTEZ BOULEVARD
BROOKSVILLE, FLORIDA 34613
PH: 352-754-4037 FAX: 354-754-4485

DESIGNED BY: HCLD
DRAWN BY: [Signature]
CHECKED BY: MKM
APPROVED BY: MKM
RICHARD L. KIRBY IV, P.E. DATE 1/22/18
LIC. NO. 44014

N696 - US19 RECLAIMED WATER TRANSMISSION SYSTEM - PHASE 1
UTILITY DETAILS (2)

PROJECT NO:
DATE: JULY 2017
SHEET NO: **D-101**